

GPI4TIC10DFV

GaN Power IC in DFN6x8 Package

Datasheet version: 2.8

Features

BV_{dss}	R_{dson}	DC bus	I_{ds}
900 V	120 mΩ	400-600 V	10A

- Ultra-low $R_{DS(on)}$
- High dv/dt capability
- Fast switching
- Low Profile
- Suitable for DC bus voltage of 400-600 V
- Smart driving with lower dynamic R_{ds} than discrete GaN FET
- **Ultra-low quiescent leakage current extending battery life**

Applications

- Switching Power Applications
- Power adapters and power delivery chargers
- Start up procedure: Please set Vdd to be a normal operation voltage (e.g., 6.5 V) before turning on the high voltage power supply or apply high voltage to the drain. Vdd is the power supply for the internal gate driver in our GaN Power IC. Only when a normal operation voltage (e.g., 6.5 V) is applied to Vdd, will the internal driver and GaN HEMT work properly.

Description

These devices are power IC based on Power GaN HEMTs using proprietary E-mode GaN on silicon technology. The gate driver is integrated with the main power transistor resulting in fast switching, high system power density and low cost.

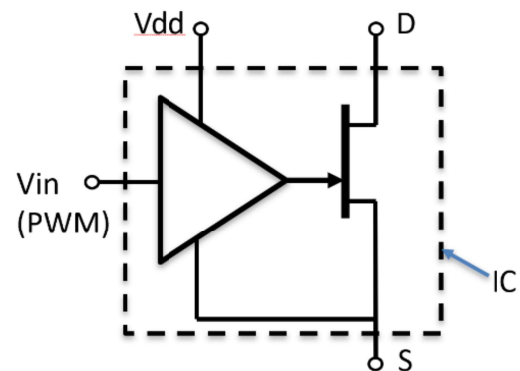
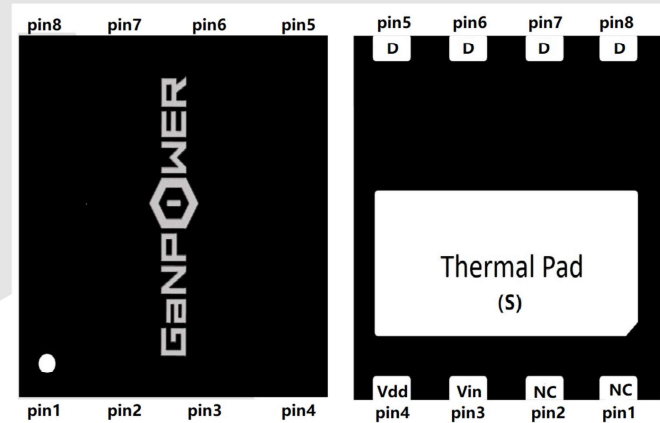

Device Characteristics

Basic Parameters				Test data			
	Parameters		Conditions	Min	Typical	Max	Unit
1	BV_{dss}	Drain-Source breakdown voltage	$V_{dd}=6.5V,$ $V_{in}=0V,$ $I_d=10\mu A$	900			V
2	R_{dson}	Static drain-source on resistance, $T_c = 25^\circ C$	$V_{dd}=6.5V,$ $V_{in}=6V,$ $I_d=2.5A,$		120	140	m Ω
3	V_{dd}	Drive supply voltage		5	6.5	8	
4	V_{in}	PWM input pin voltage		5	6.5	8	
5	I_{ddq}	Drive supply (V_{dd}) quiescent leakage current	$V_{dd}=6.5V,$ $V_{in}=0V$		0.001	0.1	mA
Switching Performance				Test data			
	Parameters		Conditions	Min	Typical	Max	Unit
1	$t_{d(on)}$	Turn-on delay time	$V_{bus}=600V,$ $I_d=3A,$ $V_{in}=6V$ $V_{dd}=6.5V$		14		ns
2	t_r	Rise time			10		ns
3	$t_{d(off)}$	Turn-off delay time			18		ns
4	t_f	Fall time			16		ns

Electrical Performance

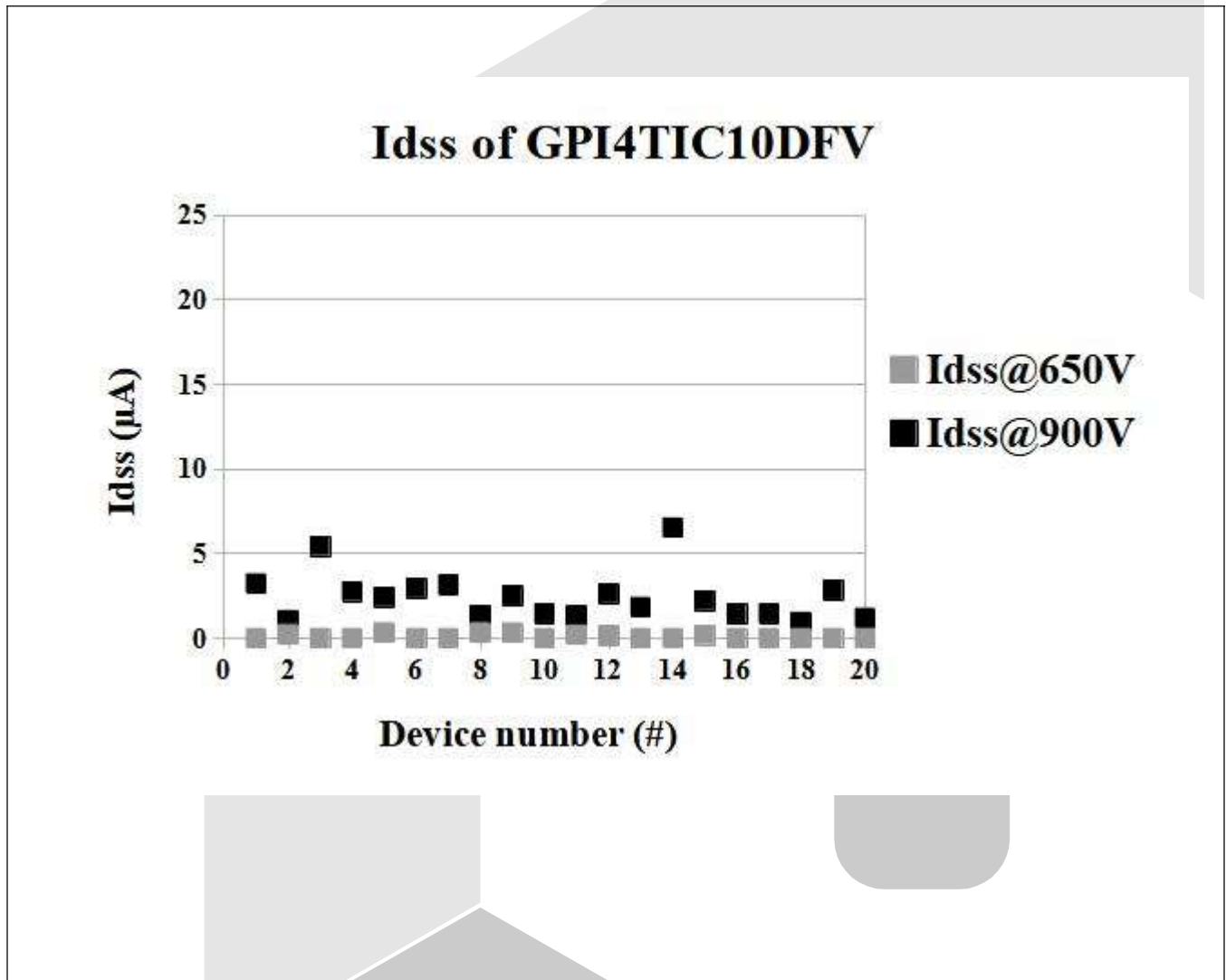

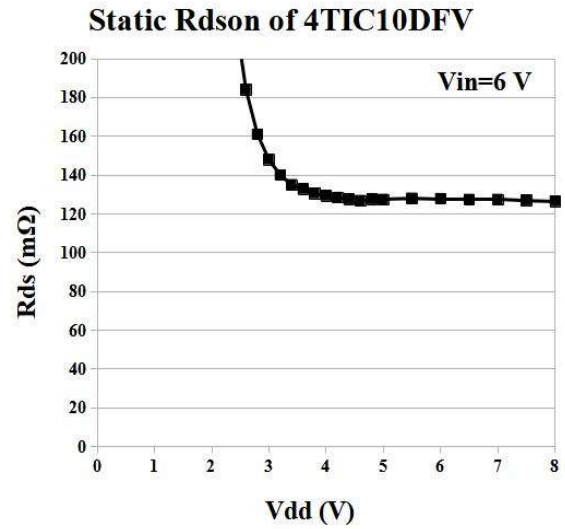
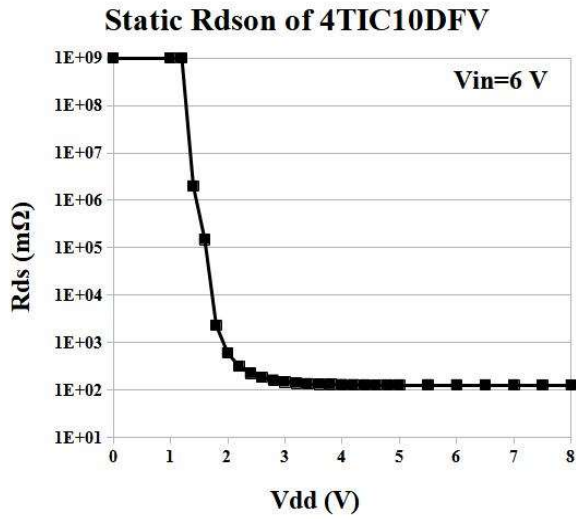

Static R_{dson} vs V_{dd} @ $V_{in}=6V$

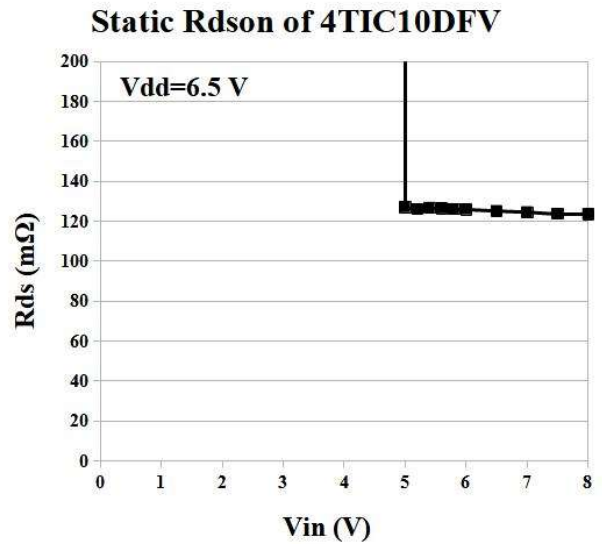
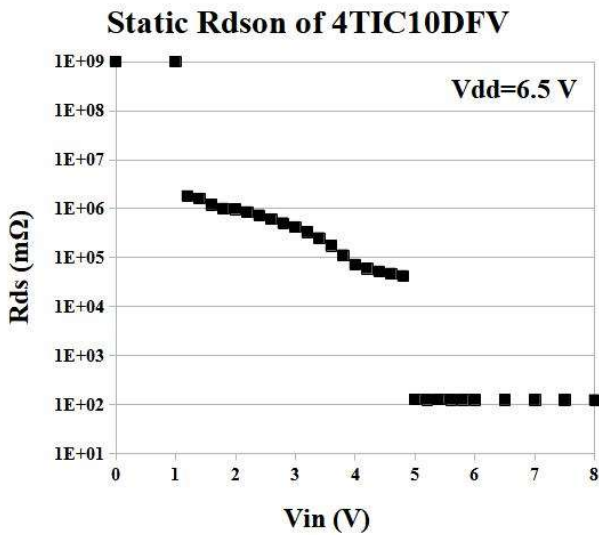

Static R_{dson} vs V_{in} @ $V_{dd}=6.5V$

Package Information

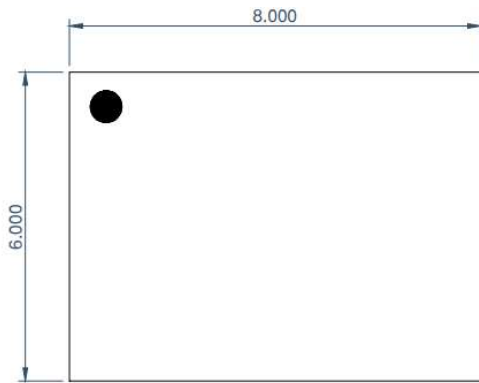

TOP VIEW

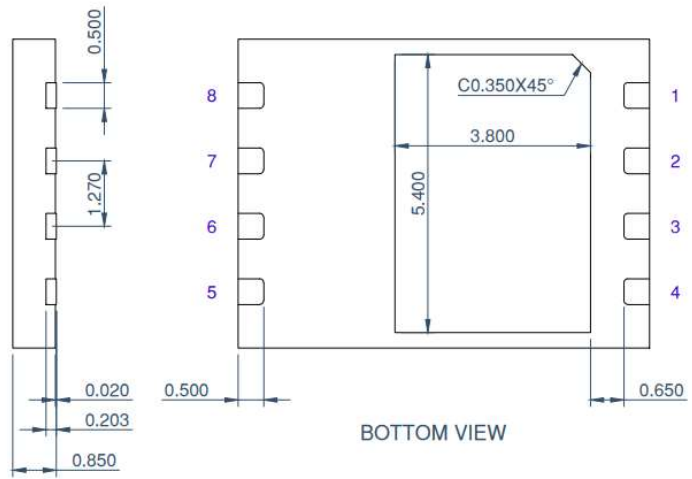

BOTTOM VIEW

PKG nom. thickness : 0.85mm (Y type)
LF THICKNESS : 0.203±0.008 THK



GaN HEMT Frequently Asked Questions

1	<p>Q: Can we do pin to pin switch for silicon MOSFET or IGBT?</p> <p>A: The short answer is no. GaN HEMT power devices are far superior than the best silicon devices such as super junction MOSFETs. However, due to different requirements of gate driving voltage and extremely high dv/dt slew rate, special drivers and optimized PCB layouts are recommended to minimize the impact from circuit parasitics.</p>
2	<p>Q: How do GaN power devices compare with SiC?</p> <p>A: Currently GaN power HEMT devices are most suitable for low to medium voltage ($\leq 1200V$) and power (<20KW) applications. GaN is the ideal choice for high frequency applications. SiC devices are better choice for high voltage and high-power applications (>20KW).</p>
3	<p>Q: Do we need to parallel an FRD for applications such as inverters?</p> <p>A: GaN devices are different from silicon MOSFET or IGBT in that they have no inherent PN junction diodes that cause reverse recovery issue. User do not need to parallel an FRD for the purpose of suppressing the body diode reverse recovery effect, since GaN HEMT can operate in both first and third quadrants. However, care should be taken for the dead time power loss since the Vsd voltage of GaN HEMT is usually close to 2V. This is especially true when a negative gate voltage is applied.</p>
4	<p>Q: Can we parallel GaN HEMT devices?</p> <p>A: Yes, GaN HEMT is ideal for paralleling, due to the positive temperature coefficient of $R_{ds,on}$. Hence, paralleling GaN HEMT devices are encouraged.</p>
5	<p>Q: What are the differences between 4TIC, 6TIC and RGIC??</p> <p>A: They are all low-side GaN ICs with integrated gate drivers.</p> <p>4TIC has lowest quiescent leakage current (0.01mA, lowest standby power loss) but require higher V_{in} voltage (5-8V, 3.3V incompatible).</p> <p>6TIC can be driven by lower V_{in} voltage (3-8V, 3.3V compatible) but has higher quiescent leakage current (6mA, larger standby power loss).</p> <p>RGIC combines an integrated voltage regulator with 6T gate driver. Two optional regulated inputs (V_{dd2} and V_{in2}) are provided for a wider input range (8-20V), which can be used to replace Si/SiC MOSFET without any level shifts for V_{gs}.</p>